

# SBL / SBLF SERIES



## Indoor LED Backlit Sign Installation Instructions

### Low Voltage ONLY!

This sign operates within an input range of 12VDC to 24VDC.

### What You Need:

- Phillips Head Screw Driver
- Control Switch (*ordered separately*)
- Appropriate Wall Fasteners
- Wire Connectors
- Pencil
- Level

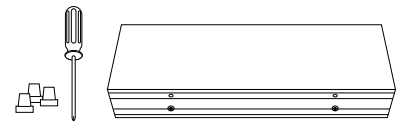

Always turn off the power prior to installation.



Be sure any metal debris cleared out of the cabinet.

## Installation Steps

- Using a Phillips head screw driver, remove the two screws on the bottom of the cabinet. With the screws removed the back will lift off the cabinet. Remove the four mounting knockouts and the center knockout for your power conduit.

- Place the back panel on the wall surface using a level to make sure it's straight. Use a pencil to mark the locations of the mounting holes on your wall surface. Drill your wall surface. The diameter of the (4) four corner mounting knockouts is 1/4" and the conduit knockout is 7/8".

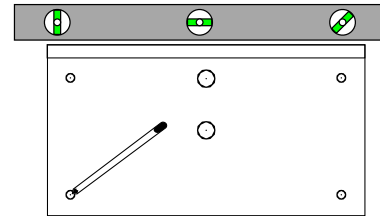
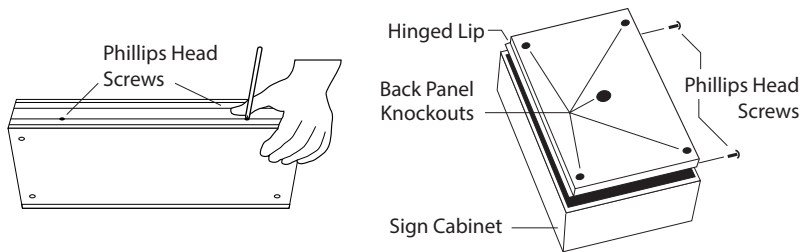

- Pull your electrical through the back panel and attach the back to the wall surface using appropriate fasteners.

- With the electrical connections made, hang the sign cabinet on the lip of the back panel you mounted to the wall. Finish your electrical connection to the sign by reinstalling the pigtail connector to the power supply. The connector is "keyed" and can only be installed in one orientation. Close the cabinet and replace the two Phillips head screws you removed in step one.

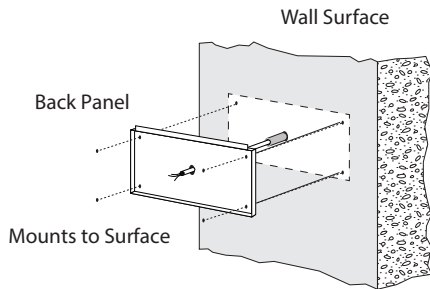

Be sure any metal debris cleared out of the cabinet.

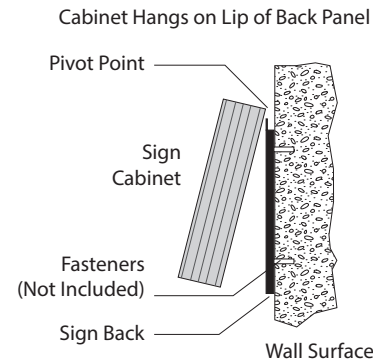

- Make your electrical wiring connections. See the other side of this page.

## Wall Mount Installation

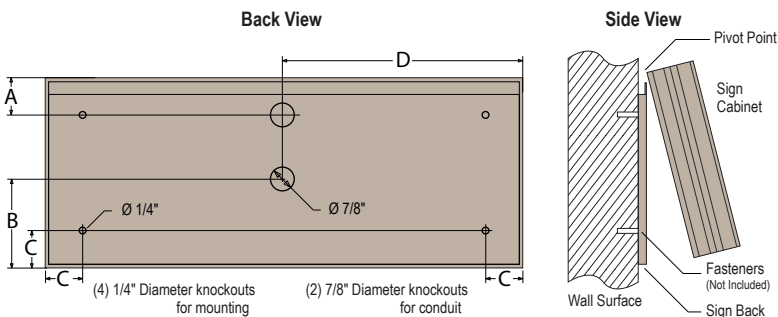

Cabinet High x Wide (Inches)	Dimension A Mounting Hole Vertical (Half of Sign Height)	Dimension B Center Knock-out Vertical	Dimension C Mounting Hole Horizontal	Dimension D Center Knock-out Horizontal (Half of Sign Width)
7 x 18	1 1/2"	3 1/2"	1 1/4"	9"
7 x 34	1 1/2"	3 1/2"	1 1/4"	17"
7 x 42	1 1/2"	3 1/2"	1 1/4"	21"
14 x 18	1 1/2"	7"	1 1/4"	9"
14 x 34	1 1/2"	7"	1 1/4"	17"
14 x 42	1 1/2"	7"	1 1/4"	21"

## Making your Wiring Connections

1. To make your electrical connections easier, gently unplug the supplied wired pigtail connector from the power supply.

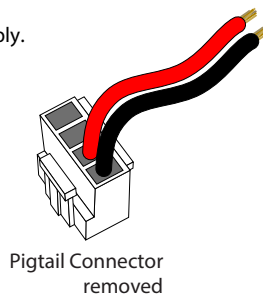
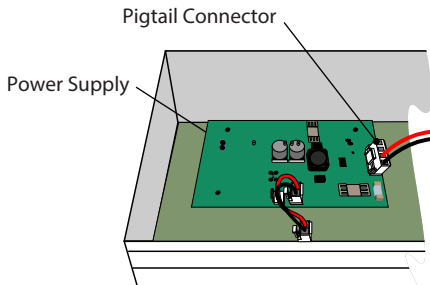

2. With your incoming power already running through the mounted back you can easily make all connections to the pigtail using wire connectors. *(See below for diagrams of the various wiring applications)*
3. Plug the pigtail connector back into the power supply to finish off the electrical part of your installation. The connector is "keyed" and can only be installed in one orientation
4. You're done with the electrical! Time to close up the sign by pushing the cabinet closed and replacing the two screws you removed from the bottom of the cabinet.



**Note:** Make appropriate wiring connections per local code.

### Single Message Sign with Single Power Supply

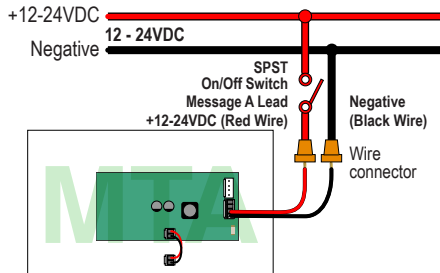

Single Message Example - [Message A] **ATM**

### Single Message Sign with Multiple Power Supplies

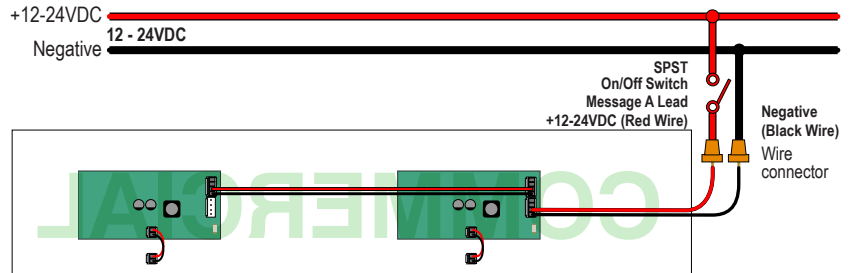

Single Message Example - [Message A] **COMMERCIAL**

### Two Message Sign with Multiple Power Supplies

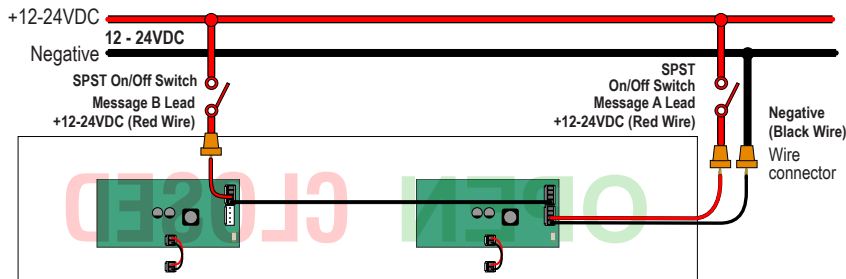

Two Message Example - [Message A] **OPEN** - [Message B] **CLOSED**

## Wiring for a Sign with Three or more Messages

When wiring a sign with three or more messages, you will have a combination of the wiring examples illustrated in this section. The Black Negative Wires will be connected together from the factory. You will have one (1) Red Positive Wire per message to connect to your incoming power.

### Three Message Sign with Multiple Power Supplies

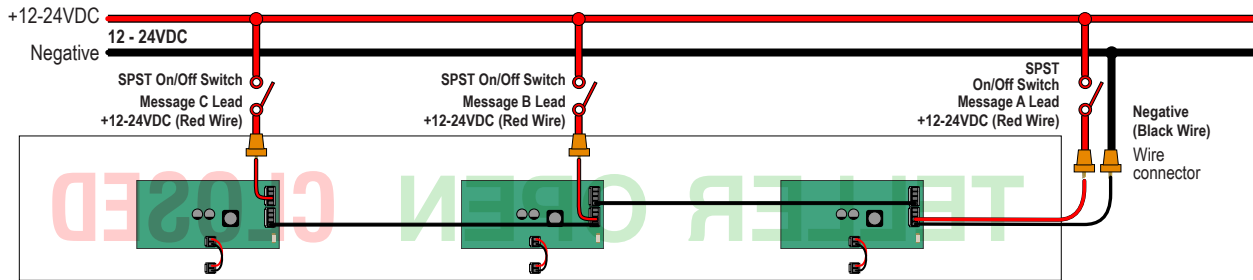

Three Message Example - [Message A] **TELLER** - [Message B] **OPEN** - [Message C] **CLOSED**



**Note:** Make appropriate wiring connections per local code.

**Note:** Any holes drilled into sign cabinet **MUST** be sealed. Failure to do so may cause a short and void warranty.

**Note:** This sign is intended to be installed in accordance with the requirements of Article 600 of the National Electric Code and/or other applicable local codes. This includes proper grounding and bonding of the sign.

## Normal Operation

There is one (1) LED on the power supply located close to the connector with the Red and Black wires. This LED marked V OUT, will illuminate green when 12 - 24VDC power is applied to the Pigtail.

Check the LED on each power supply since there may be more than one power supply per message.

